



NDN COLLECTIVE

# CARING FOR WATER

BY

**DR. PENNELYS DROZ**

POWER BUILDING & CURRICULUM COORDINATOR

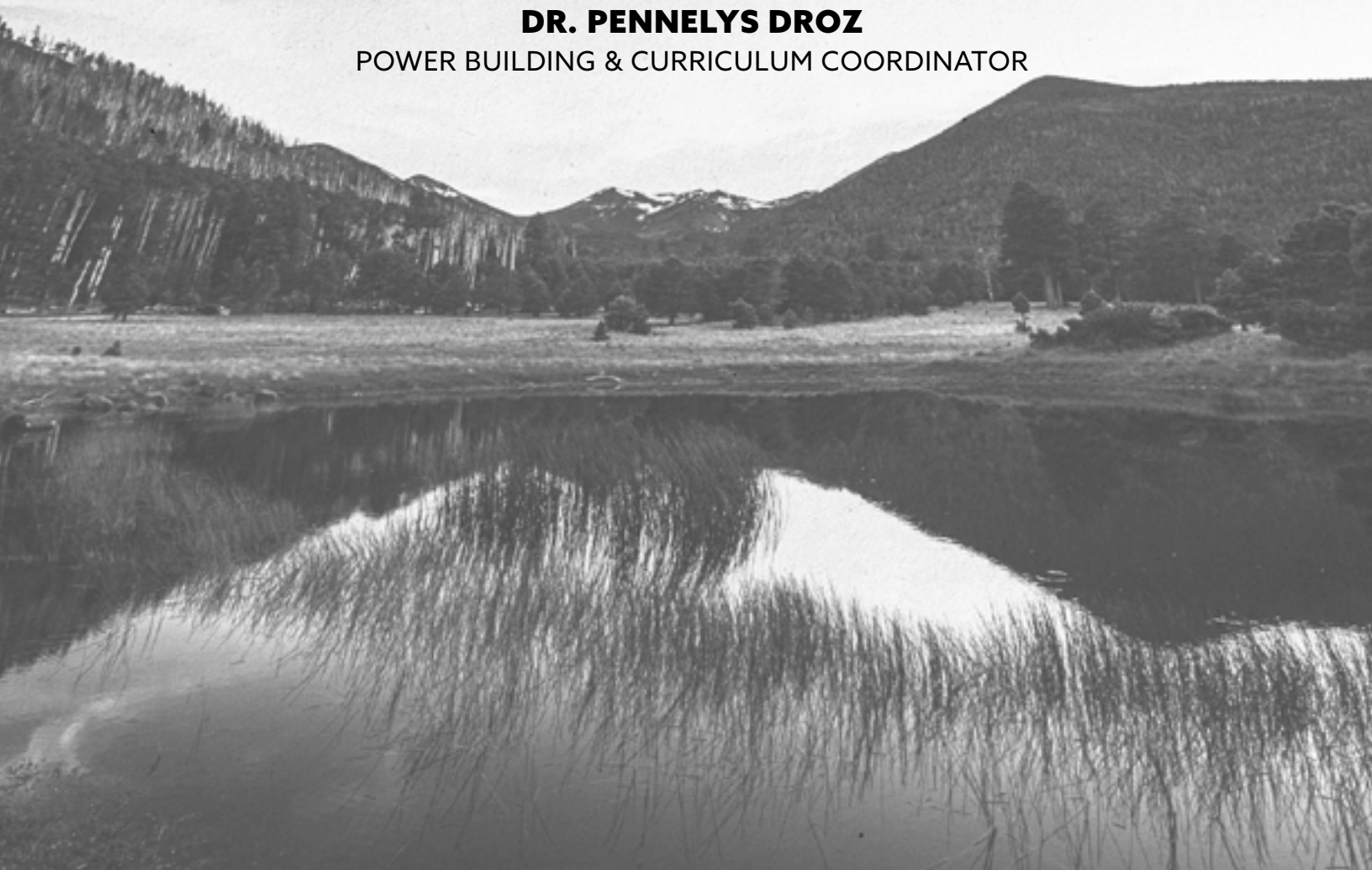

# TABLE OF CONTENTS



1. THE SACRED RESPONSIBILITY OF WATER	3 - 4
2. WATER PROTECTION	5 - 8
3. WATER INFRASTRUCTURE	9
4. ECOLOGICAL SYSTEMS FOR FILTRATION	10
5. RAINWATER	11 - 20
6. WASTEWATER TREATMENT	21 - 22
7. ECOLOGICAL CARE OF WASTEWATER	22 - 35
8. COMPOSTING TOILETS	36 - 39
9. FINAL WORDS	40
10. RESOURCES	41 - 44

# THE SACRED RESPONSIBILITY FOR WATER



We understand Water is a living sacred entity that is the source of health and life. As we take care of our Nations' needs for clean water, we need to ensure our water rights, develop our self-determined water usage and water quality policies and programs, and utilize infrastructure choices that care for and heal the lands we are responsible for.



**“As Indigenous Peoples, we raise our voices in solidarity to speak for the protection of Water. The Creator placed us on this earth, each in our own sacred and traditional lands, to care for all of creation. We stand united to follow and implement our knowledge, laws and self-determination to preserve Water, to preserve life.”**

Indigenous People's Caucus Declaration on Water,  
presented at the Second National People of Color Environmental Leadership Summit, 2001.

Indigenous peoples have been centering our spiritual responsibilities to the Water, and bringing these responsibilities into action. The Great Lakes Water Walks, beginning with the vision of Josephine Mandamin-ba, have extended beyond the Great Lakes to connect rivers and the oceans spiritually, inspiring and empowering thousands of people to commit themselves to caring for Water. The impact of the struggle against the Dakota Access Pipeline at Standing Rock is another expression of this commitment. Every day, somewhere, Indigenous peoples gather vision and voices to protect the Waters, from the birthworkers movement, to pipeline struggles; to the work against industrial contamination of waterways, to the small daily prayer and ceremony carried forward by our family members.

The Anishinabek Nation's work for the water is an example of putting spiritual responsibility into contemporary governance protocol. They have developed guidance for ensuring spiritual voice and foundation in legislative and international water decision and policy making. In keeping with the understanding that Water is in the care of women, they have an Anishinaabe women's water commission to guide their work, and have named Autumn Peltier, a young Anishinaabe woman from Manitoulin Island, their Chief Water Commissioner. She is working to have the rights of Water legally recognized and is a powerful voice of her people.

Water is sacred, but has been treated as a commodity; a property interest to be bought, sold and traded in the colonial capitalist economic and legal system. Water rights are being manipulated to serve economic and political interests. Water is being depleted or converted into destructive uses. This sacred element is being exploited through large dams, diversion projects, mineral extraction, energy production, recreational & agricultural industries, and privatization led by bottled water companies.

Defending our waters, not contributing to their abuse and contamination, and healing our waters through remediation are all our responsibilities as people of Earth.



## WATER PROTECTION

Water protection is necessary on all fronts; from organizing communities and allies to resist destruction, to practicing our inherent rights to water, demanding our politically recognized water rights are honored and extended, and designing community infrastructure that cares for water in keeping with natural cycles. Water governance structures that impact Indigenous communities and Nations are complex. In colonial Canada, for example, colonial government responsibility for water resources is managed by the province, sometimes with local watershed-based organizations having strong responsibility. Water resources on First Nation reservations are under federal legal responsibility, however, and provincial regulations don't apply. These conflicting jurisdictional boundaries and a history of racism and neglect result in fragmented governance structures, inconsistent planning and management programs, and a patchwork of drinking water quality regulations and standards. There are currently no enforceable consistent water quality regulations for First Nations, although there are various political solutions being proposed and navigated. Within the colonial United States, a similar situation exists. The federal responsibility is carried by the Bureau of Indian Affairs, with approaches guided by the Environmental Protection Agency, the federal Safe Drinking Water Act, and the Clean Water Act. States can design their own water regulations in keeping with the SDWA, but Tribes are required to apply to the federal government for 'Treatment as a State' status to be able to design and determine their own legally recognized water regulations. Jurisdiction is complex, site-specific, and rights are often contested.

In the Constitution of Mexico, water is considered a resource that is property of the State and as a result there is a great water crisis in Mexico. Transnational companies have more water available from the concessions than the populations themselves who have cared for the rivers, springs and forests. The current struggle of the people is for the recognition of water as part of the territory, recovering the administration of water to help it return home and take care of it as a relative. In Mexico, some towns have managed to recover water administration; however, these are just the first steps toward the full recognition of water as territory, protected by laws as the right to self-determination.

It is recognized universally that protection of the ecology of 'source water' (the source of drinking water) is critical for healthy water for communities, but Indigenous presence in watershed-level decision making is not standard practice. This is a space of necessary advocacy and action, particularly because the colonial development of water resources and the expansion of resource extraction activities that impact Indigenous watersheds continues without consent from impacted communities, resulting in dammed rivers and flooded valleys to polluted surface water and contaminated groundwater.

There is an international movement to recognize the legal rights of 'Nature' which has gained certain traction in specific cases. This may be a path that can guide the centering of Indigenous care and decision making related to water. In a precedent-setting case, the Maori of Aotearoa, or colonial New Zealand, after extensive organizing and legal challenges, achieved the recognition of personhood status for the Whanganui River. The law declares that the river is a living whole, from the mountains to the sea, incorporating all its physical and metaphysical elements. The law was part of a settlement with the Whanganui Iwi, comprising Māori from a number of tribes who have long viewed the river as a living force. The novel legal approach set a precedent that has been followed by some other countries including Bangladesh, which in 2019 granted all its rivers the same rights as people. The result of this legislation is that before any development impacting the river moves forward, the Maori people have to have decision making authority that guides what is able to occur.

**It is critical across the board for Indigenous Nations to legally quantify and demand recognition for water rights, not only for what is needed for the present, but what will be needed in the future, assert decision making authority in all watershed decision making, and support our frontline water defenders that are resisting the devastation of our sacred waters.**



## Water in the International Rights of Indigenous Peoples

By: Alvaro Mena

The basis for Indigenous design is the learning relationship and responsibilities between people and In UNESCO's 2001 Universal Declaration on Cultural Diversity, UN countries recognized the *"contribution of traditional knowledge, in particular on the protection of the environment and the management of natural resources, and the promotion of synergies between modern science and local knowledge."* This is an important precedent to identify the achievements that have been obtained at the supranational level with respect to the rights of peoples to the commons and sacred water.

Water is a living and sacred element, which is often not recognized within legal frameworks. However, thanks to the struggles that are taking place on different fronts by Indigenous peoples, this is gradually changing.

Article 25 of the United Nations Declaration on the Rights of Indigenous Peoples states that:

*"Indigenous peoples have the right to maintain and strengthen their own spiritual relationship with the lands, territories, **waters**, coastal seas and other resources that they have traditionally owned, occupied and used and to assume their responsibilities in this regard towards future generations."*

These non-binding mechanisms issued by these international bodies are important tools to be able to continue defending the Sacred Water as part of our worldview as indigenous peoples in the face of the multiplication of threats that loom over our territories.

In Mexico, Convention 169 of the International Labor Organization (ILO) is another of our legal tools. This is a binding agreement for the defense of the rights of the Sacred Water and the relationship that the peoples have maintained with it.

In the exercise of these rights, in Mexico, the Coordinating Committee of United Peoples for the Defense of Water (COPUDA) managed, after several years of organizational and legal struggle, to get the Mexican government to grant them a community concession to manage the use of water from their 17 villages. They are currently developing their own community statutes for water management.

Indigenous peoples have legal tools that we can use to defend the Sacred Water because the lives of our peoples and humanity depend on it. It is no coincidence that a large part of the resources that are conserved are located in Indigenous territories, and it is our great commitment to Mother Earth to continue conserving them.

## Treatment as a State Status and the Isleta Pueblo

In 1998 the Isleta Pueblo won a case in the Supreme Court, affirming their right to require the City of Albuquerque to maintain the water quality within the Rio Grande. The Isleta Pueblo is six miles downstream from where Albuquerque dumps 55 million gallons of wastewater each day, which was contaminating the Tribe's water for irrigation and ceremony. When the Clean Water Act was amended to include Treatment as a State rights for Tribes, Isleta immediately acted. They established a water quality standard that was many times cleaner than the current federal standards, and gave Albuquerque a three year period to upgrade its sewage treatment facility. Albuquerque sued, and the case went all the way to the Supreme Court, where ultimately the rights of the Pueblo were affirmed. This case was a precedent-setting case and inspiration for other Tribes.

A list of Tribes with TAS status and applications can be found here:

<https://www.epa.gov/wqs-tech/epa-actions-tribal-water-quality-standards-and-contacts>

## WATER INFRASTRUCTURE

Conventional water infrastructure was not designed with water care in mind. Our hard, impermeable landscapes cause flooding, and fast water runoff issues that degrade land, and prevent water from infiltrating into the soil to create healthy ecologies. Standard water infrastructure is designed to try to control water, remove it, or store it in massive water containment reservoirs, with metal or concrete culverts and pipes that also contribute to high-speed water runoff and land degradation.

There are other ways to design and develop water infrastructure, however, that care for the Earth and our relatives. These approaches are now recognized as best practice in design, and can be implemented by our communities and Nations as expressions of our responsibility to care for water.

Water delivery and treatment systems have consistently been underdeveloped and underfunded in our communities. There are various competitive grants and funding pools to apply for but in order to protect our water sources, and provide clean drinking water to our Nations, we will need to obtain further significant financial resources and training. In order to reduce our financial burden and ensure that we use water with honor and respect, we must take water efficiency precautions in our homes, agriculture, and businesses. We should also look to natural and ecological approaches to water purification and treatment. These systems, relying on the cultivation and restoration of diverse watershed ecologies, are dramatically more affordable while also caring for the land and creating enhanced diversity, wildlife and wetland plant habitat.



## Ecological Systems for Filtration

Wetlands and healthy plant communities naturally purify water. They do this through filtering out particulates, breaking down toxic compounds into benign molecules, and uptaking heavy metals, including radioactive uranium!

Wetlands and healthy ecologies filter water naturally through three interconnected processes. The first process is sediment trapping, which occurs when soil filters water naturally by physically removing large debris and particles as water percolates down through the soil layers. The second process is nutrient removal, where plants uptake excess nutrients in the water, and bacteria and microorganisms in the soil further break down these excess nutrients. The third natural water filtration process is chemical detoxification, facilitated by bacteria and other microorganisms breaking down harmful contaminants and chemicals, or when the plants themselves convert them into less harmful chemicals.

New York City invests into the health and biodiversity of the forests and wetlands in upstate New York that purify and filter their drinking water. San Francisco, Portland, and Seattle also rely on caring for the surrounding ecologies to purify their water. These strategies lend themselves to working with and renewing our traditional knowledge of healthy wetland ecologies as the foundation of our clean water systems.

If your watershed is not significantly vegetated, water can be purified with sand filters and constructed biological filters to bring water quality up prior to ultraviolet disinfection, possible chlorination, and dechlorination processes.

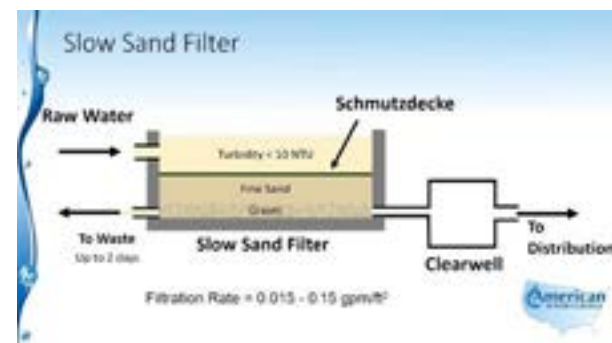

Film on slow sand filter design from American Water College  
[youtube.com/watch?v=fBKIXDx6txo](https://www.youtube.com/watch?v=fBKIXDx6txo)

## What is your Watershed?

A watershed is an area of land that drains or “sheds” water into a specific body of water. For example, watersheds drain rainfall and snowmelt into streams and rivers. These smaller bodies of water flow into larger ones, including lakes, bays, and oceans.



What is your watershed? Where does the water come from to arrive at your location? Understanding your watershed will help you understand potential threats to the safety of your water, and how to partner with others to advocate for the health of the water.

## Rainwater Harvesting Strategies

There are two basic approaches to rainwater collection: **passive harvesting**, in which the land is worked with to collect, store, and filter rainwater, and **active harvesting**, in which rainwater is collected from a surface for cistern storage. Traditional Indigenous rainwater harvesting strategies have used both methods

### Where to Begin

#### 1. Observation

When seeking to develop rainwater harvesting techniques for your site, the first thing to do is patiently observe.

How does water flow through the land? Do you see erosion marks? Where is vegetation the richest? Are there water loving plants in certain areas? Determine where the top of your site’s watershed is and discover how that water flows through the land. Are there contamination sources? What is the life-dynamic of your whole site? How do winds move through? How about people and animals? Sun motion? Sketching your observations is helpful.

#### 2. Mapping

The watershed of the land is your ‘catchment area,’ or the area you could potentially harvest water from. Identify your needs: Do you need water for irrigation? Orchards? Do you need to mitigate flooding issues? Create a map of your watershed, mark your points of use or regions of challenge.

### 3. Design

Simple designs using the power of gravity are always best. How can you slow the water down? How can you help the water infiltrate into the soil? How can your water harvesting design offer multiple benefits to the abundance of the ecology of your site? There are many techniques for this. Plan for water overflow and design a use for the overflow - possibly to irrigate drought resistant plants.

## LAND-BASED (PASSIVE) RAINWATER HARVESTING TECHNIQUES

### Check Dams

Check Dams are built with rock along natural washes, to slow the water down, infiltrate it, and sometimes divert it.



### Sheet Flow Spreader (media luna), a type of check dam

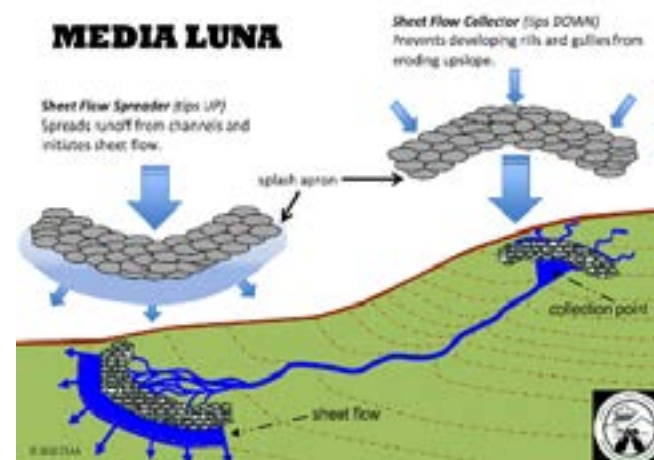

### Berms and Basins

Berms can be shaped with soil, or rock-stabilized soil. Berms slow water down, and help it infiltrate into the soil. The basin behind the berm can be deep or shallow, depending upon the need, and can be mulched, planted, or not. Berms can also be made with intentional spillways, a great technique to use when building terraced gardens or fields.



### Swales

A 'swale' is essentially an extended berm system, designed on contour to the slope of the land. This diagram demonstrates a swale with rocked spillways for overflow. The contours of the land are the lines that are demonstrated on a topographical map, shown below. When swales are designed to follow these lines, they can catch and slow water according to natural flows without contributing to erosion.



## Mulch, (Rock Mulch, Organic Mulch, living mulch)

Organic, rock, or living mulch help retain, slow, and infiltrate water into the soil. Organic mulch includes shredded bark, straw, or any other dead organic matter. Rock mulch is strategically placed rock intended to shade and retain water in the soil. Living mulch is living groundcover plants that also serve the purpose of mulch.



## Infiltration Basins/Rain Gardens (also called bioswales)

Infiltration basins are designed with layers of drain rock or gravel, sand, and vegetative mulch to both infiltrate and provide biological water treatment. The basic French drain functions as a minor infiltration basin that is used often in wet climates to prevent flooding and standing water near homes and buildings.

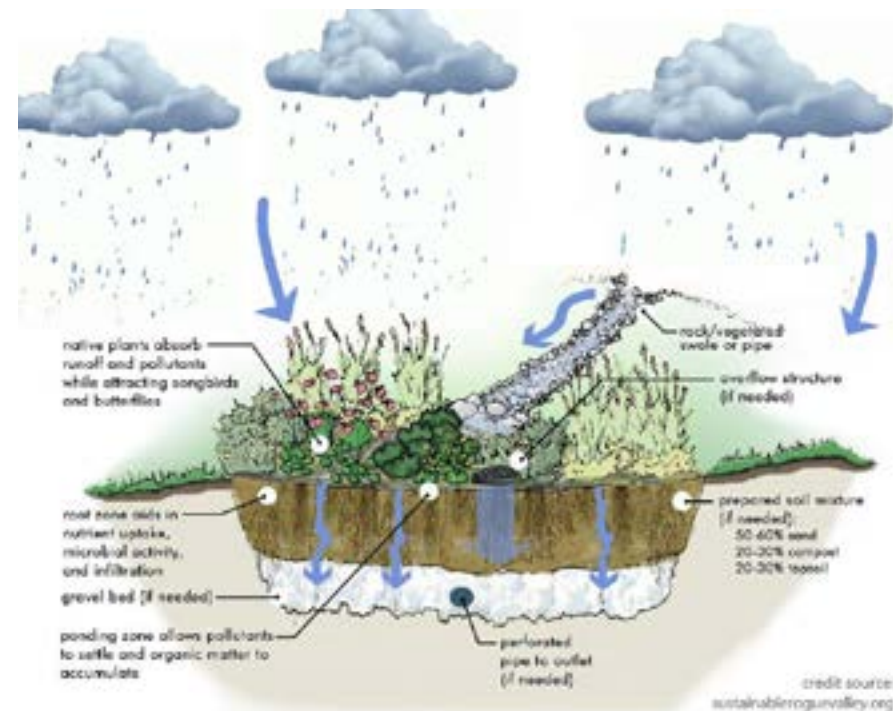
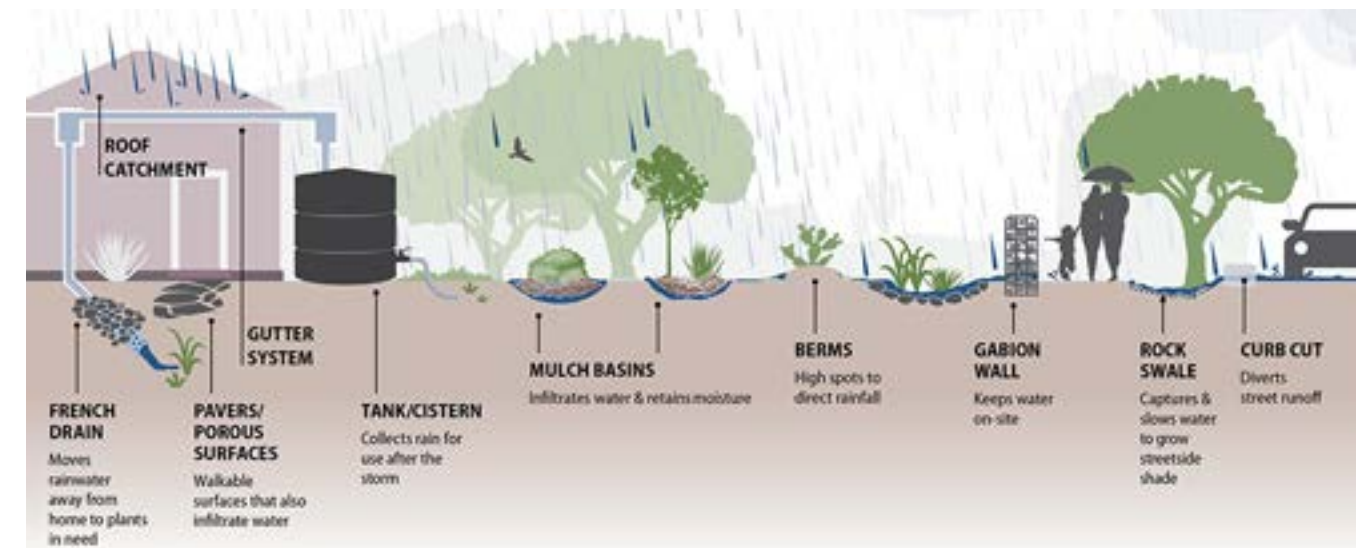

## Calculating your Rainwater Harvesting Volume

### Metric

Catchment Area (m<sup>2</sup>) x Average annual rainfall (millimeters) = Total rainwater/Year in Liters that falls on your site.

### Imperial

Catchment Area (ft<sup>2</sup>) x Average annual rainfall (inches) = Total rainwater/year in gallons

To measure overflow water, or the runoff you'll need to manage, you will need to multiply this volume of rain by its runoff coefficient; the percentage of rainwater that runs off the type of surface the rain is falling on.

### Runoff Coefficients

Roof or impervious surface: .80-.95

Bare earth: .35-.55

Grass/vegetated area: .10 - .25



## ACTIVE RAIN HARVESTING

Active harvesting of rainwater involves the use of a cistern, (water holding container). Cistern systems can be designed for non-potable uses such as washing, gardening, or flushing toilets, or potable (drinking) water quality collection.

### Roofing Choices

You will want to choose a roof surface that is safe for the intended purpose of your cistern use. The best surface for potable water harvesting is a **standing seam metal roof**. The American Rainwater Catchment Systems Association (ARCSA) advises that “standing seam roofs, powder coated or enameled, Galvalume (zinc + aluminum alloy) with non-toxic baked or enamel finish are appropriate for potable use with non-toxic finishes and appropriate components, tanks, and post-tank treatment.”

**Corrugated metal** is galvanized, which will leach some zinc into the rainwater. Collect a sample of rainwater and use a home test kit or send it to a lab to make sure zinc levels are below allowable limits. Zinc is an herbicide, so even if you won't be drinking the water, you'll want zinc levels to meet that standard to avoid hurting your plants.



**Clay and concrete tiles** have lower collection efficiency because they are porous and absorb water, but clay tiles will give off a high-quality water. Concrete tile can leave alkalinity in your water, but a home test kit will allow you to measure your pH.



**Asphalt shingles** are questionable. When they are new, and then again when they are old and degraded, they can leach contamination into your water. Not recommended for potable water.

### Do Not Use

**Cedar Shakes** are usually treated with fire retardants. Water samples can be tested to make sure the water is clean. This water may be suitable for irrigation.

**Copper** is naturally resistant to algae/moss growth because it is an herbicide. Copper will leach into your rainwater, so if you are using the water for garden irrigation, copper isn't an ideal choice.

**Lead** flashing is still available in some places so test for lead if you're harvesting for drinking water.

**Biocides:** Some rooftops are treated with biocides. Zinc- or copper-treated shingles are common in the Pacific Northwest to curb mold, moss, and algae growth on the roof. If you're harvesting for irrigation, make sure your biocide levels are low enough not to hurt your plants, they can leach contamination into your water. Not recommended for potable water.

### Cistern Choices

The ideal cisterns or barrels are opaque, metal, ferrocement, wood, or colored plastic. This inhibits the growth of algae and bacteria. The barrel or cistern has a cover, and a screen on the end of downspouts leading to the barrel to prevent litter or contamination. An opening or spigot is fitted to the bottom of the cistern or barrel, allowing gravity to pump the water when the spigot is opened. When harvesting water for potable use, a 'roof washer' is added, which allows the first several gallons of collected rainwater to be discarded, as well as a UV or other filtration system.

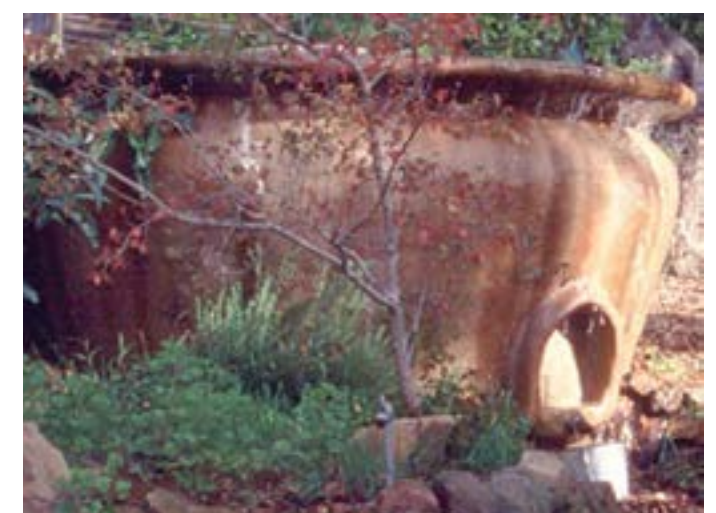

## CISTERN SYSTEM COMPONENTS:

From 'Rainwater Harvesting for Drylands' by Brad Lancaster

1. Catchment Surface
2. Gutters and Downspouts
3. Screening for cistern/downspout openings
4. First flush system
5. Cistern
6. Vent
7. Overflow
8. Faucet and valve
9. Filters and pumps

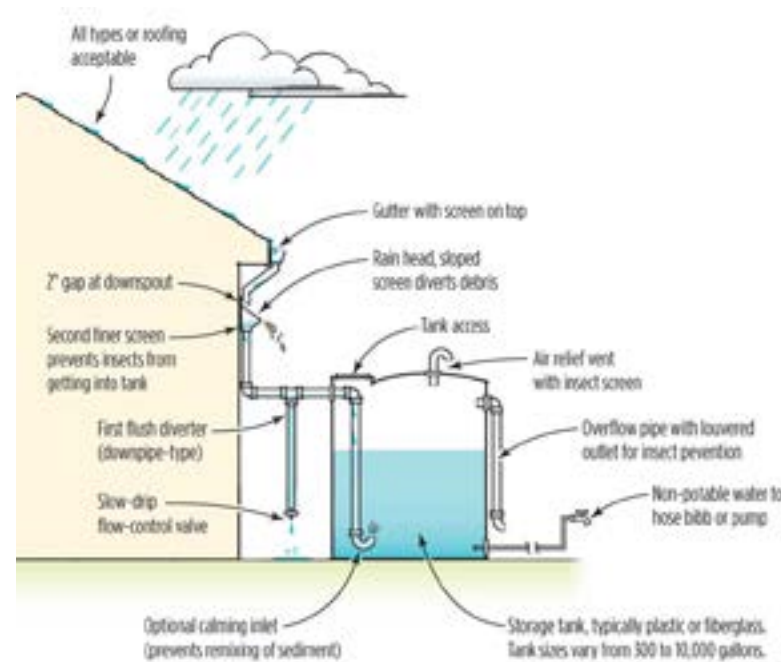

## RAINWATER HARVESTING PRINCIPLES

### 1. Ensure adequate inflow:

Size your gutters, downspout and inflow pipe to handle the maximum rainfall intensity likely to occur in your area.

### 2. Ensure adequate outflow and use it as a resource:

The diameter of the cistern overflow pipe must be equal to or larger than the diameter of the cistern's inflow pipe so that your cistern doesn't back up. Direct your overflow resource to another tank or mulched and vegetated infiltration basins

### 3. Design your system to collect high quality water;

Aim to use all materials that are rated for potable water.

### 4. Design a closed system that filters itself:

Closed cisterns that are screened off from sunlight and insects so that algae and bacteria won't grow and contaminate your water. Construct the outflow pipe from the cistern a minimum of four inches above the bottom of the cistern to keep the sludge of sediments from being pulled into the supply pipe.

### 5. Maintain access to your tank and its interior:

You need to check water levels, clean out the tank and make repairs. Above ground cisterns need to have space to walk completely around them.

### 6. Vent your tank:

All covered tanks with tight fitting tops must be vented to prevent a vacuum from forming when large quantities of water are drawn from the tank.

### 7. Use gravity;

Place your tank at a location where you can utilize the elevation of the catchment surface and the power of gravity to collect rainwater and distribute it.

### 8. Make rainwater use convenient:

Where possible, select your tank location to be near both the water source (roof) and the destination, minimizing the length of downspouts, pipes, and hoses.

### 9. Site your cistern so it serves multiple uses:

You can design your cistern to be part of a privacy screen, fence, or shade structure.

### Rainwater Harvesting System with Plumbing to Home Interior for non-potable use

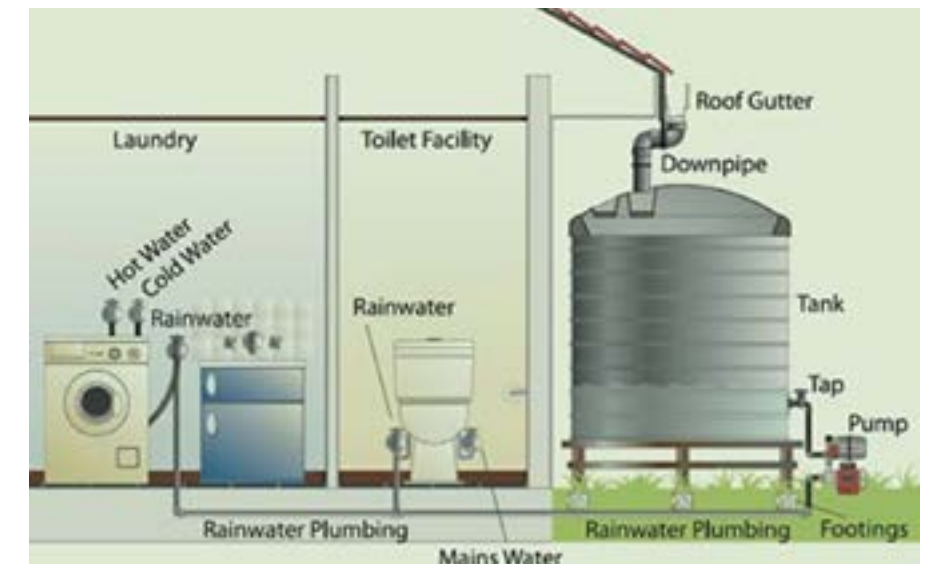

## HOUSEHOLD RAINWATER COLLECTION

If your goal is to have a household that subsists on rainwater primarily, you can calculate that using this formula:

**Number of people x daily water consumption x longest drought period = needed storage capacity**

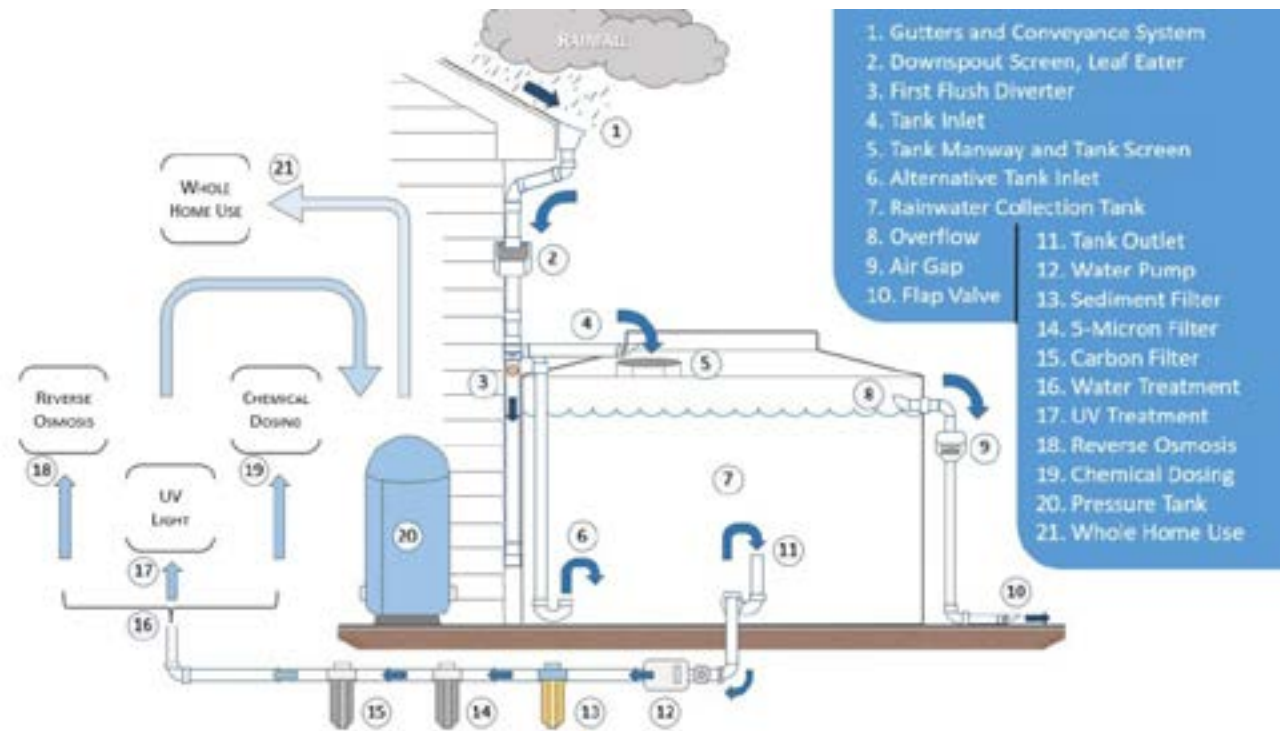

Rainwater harvesting with cisterns is also something that can be accomplished over a wide variety of scales. Home or business scale cistern use is well known, but industrial complexes and municipalities can also utilize cistern collection and storage. For example, the University of Arizona in Tucson harvests rainwater from its campus, maintaining an immense million-gallon underground cistern with pumps to utilize the water when needed.

Rainwater harvesting, both land-based and active, can be an important fresh water source and climate resilience strategy for our Nations.

## 'WASTEWATER' TREATMENT

Water enters our buildings relatively clean, and we can ensure that it is returned to the ecology in a good way. Our current systems of 'wastewater' treatment are truly wasteful.

Before the creation of the flush toilet, human 'waste' or 'night soil,' was applied to the land, and purchased as a valuable commodity. As cities increased in size, the 'scavengers' or 'night soil collectors' were unable to keep up with the job, so overflow would occur, and additionally, their carts would 'almost always' leave a trail of manure down the street – not the best practice for human health. So, in response to the demand for an alternative, people created "water closets" and "earth closets." Earth closets were an in-house system where waste was covered by a layer of earth, to be disposed of later. Water closets were created to immediately remove waste from the house, usually to a tank outside. Water closets were more preferred at the time, so became the leading technology, and what resulted was our complex sewage systems and treatment facilities, created in response to the need to manage this overflow and increased risk of infection posed by lacing large amounts of water with fecal matter. Currently, our standard wastewater systems are troubled.

### **1. They use too much water.**

Every day, most of us use an average of 1.5-5 gallons of drinking-quality water just to flush a toilet once! The average person in North America uses 7,300 gallons of drinking water each year on toilet flushing alone!

### **2. They cause pollution.**

Household wastewater is additionally combined with stormwater and industrial wastewater, creating a mix of potential human pathogens, fossil fuel contaminants, and various other toxins, then is treated with chemicals (some of which are carcinogenic), and discharged into rivers, oceans, lakes, or injected into our groundwater. Treated sewage effluent is rich in carbon dioxide, nitrate, and phosphate, creating eutrophication of lakes and rivers into which it is disposed. Piping often contains cadmium, lead, or asbestos (old concrete piping).

### **3. The systems are expensive.**

It is unfeasibly expensive to clean the water back to drinking water quality after being additionally contaminated with stormwater and industrial wastes.

### **4. It disposes of a potential resource**

Water is precious. Human manure and urine, properly dealt with, are an extremely valuable and free soil amendment!

### A NOTE ABOUT SEPTIC SYSTEMS:

Septic tanks and soil absorption systems (leachfields) are meant to settle out solids and drain the effluent into the ground. Nutrients and toxic chemicals are not always effectively removed in this process. **Adsorption** occurs in leachfields, in which particles and chemicals **adhere** to soil particles, where biological and chemical processes can break them down. This can be very safe and effective, depending upon your soil type, where the groundwater flows, and how low your pipes are buried. Pipes are typically placed 2 to 10 feet below the surface – far too low for active soil microbes and plants to reach it. The most microbial activity occurs in the top 18 inches of soil. Additionally, the leftover sludge is again, just simply taken to your standard wastewater treatment plant.

## ECOLOGICAL CARE OF WASTEWATER

After water is used in our homes, agriculture and businesses, we can also work with ecological systems to clean and purify the water, returning it to the land or waters in a good way. Residential scale greywater systems, combined with the use of composting toilets, can ensure that the water coming from your home is returning to the Earth in a good way. Constructed wetlands, designed to mirror natural ecosystems, can be used to treat sewage while providing habitat and oases for animals and birds. The City of Arcata's sewage and wastewater treatment consists of a series of constructed wetlands, featuring an educational center to teach the public about the system.

**Plants, soil bacteria, fungi mycelium, earth, sand and gravel work naturally to purify and filter water and soils.** Specific plants can break down or uptake particular contamination sources. For example, sunflowers reduce heavy metals in soil and water by 43% and have been used to clean up radioactivity contamination, white willow can filter harmful bacteria, including E.coli, and cottonwoods and poplar have been used to clean up TCE groundwater plumes



Learn more about the City of Arcata's wastewater sewage treatment marshes here!  
[www.arcatamarshfriends.org/the-marsh/wastewater-treatment/](http://www.arcatamarshfriends.org/the-marsh/wastewater-treatment/)

### PERMEABLE PAVING

Rainwater is precious, and strategies can be employed to both prevent flooding and help stormwater filter slowly into the ground and wetlands, where it undergoes natural treatment. Stormwater can be treated through using passive water harvesting methods to direct the water slowly to infiltration basins. Another means of caring for large amounts of stormwater is the creation of constructed wetlands; wetlands that are designed to facilitate the purification of water.

The Tulalip Tribe in Washington, and the Pinoleville Pomo in California both utilize constructed wetlands to treat stormwater. Val Streeter, stormwater planner for the Tulalip, said,

*“For fish it’s much better to address your stormwater naturally as it would happen without us. So that’s why we’re getting away from the conventional stormwater treatment – pipes, curbs, gutters, detention ponds – and moving into more natural treatment, where you don’t disturb the land as much and try to mimic nature to the greatest extent possible.”*

The incident of flooding and stormwater management challenges can also be dramatically reduced by reducing the amount of hardscape. When we pave driveways, parking lots, and roads, it creates a hard, impermeable surface where rainwater collects and picks up speed, leading to erosion, flooding, and contamination of soils and waterways with vehicle emissions and toxins from the asphalt. Infiltration basins and stormwater gardens can help purify this water, but it is important to carefully consider whether to pave. If pavement is necessary, there are now permeable paving techniques that can be used for roads, sidewalks, and parking lots, allowing water infiltration and slowing down the flow!



### PERMEABLE PAVING

Permeable Paving is a strategy to reduce flooding and runoff caused by pavement. There are several different types, ranging from interlocking concrete, to ground porous concrete, or porous asphalt.



## CONSTRUCTED WETLANDS

Natural wetlands are Mother Earth's way of purifying and renewing the health of water. Constructed wetlands, on large scales, and greywater systems/wastewater gardens, on residential scales, rely on the cultivation and restoration of diverse watershed ecologies to purify water, and are dramatically more affordable than standard systems. They also create enhanced diversity, wildlife and wetland plant habitat.

Constructed wetland systems pretreat wastewater by filtration, settling, and bacterial decomposition in a lined marsh. Plants use the nitrogen, phosphorus, and other compounds, producing oxygen and releasing sugars, and other microbial nutrients in their root zone, which increases microbial decomposition and treatment of solids and pathogens.

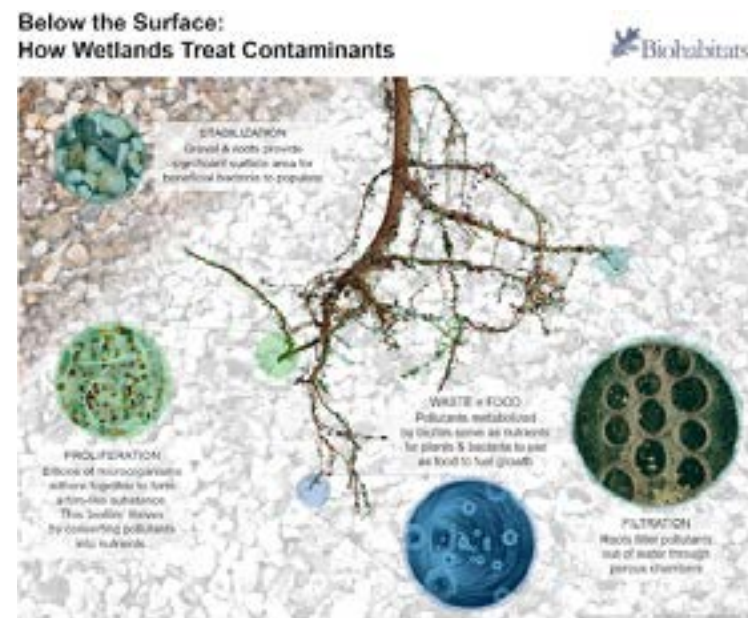

### TYPES OF CONSTRUCTED WETLAND:

The two major types of constructed wetlands are **surface flow** and **subsurface flow**.

**Surface flow** wetlands consist of shallow basins in soil or any other media that will support plant roots. This type of wetland most closely mimics natural marshes. A surface flow wetland generally has a soil bottom, emergent vegetation, and a water surface exposed to the atmosphere. The water moves through the wetland above the substrate slowly. Areas of open water may or may not be incorporated into the design. Plants in these surface flow systems can withstand continuously saturated soil conditions and the corresponding anaerobic soils.

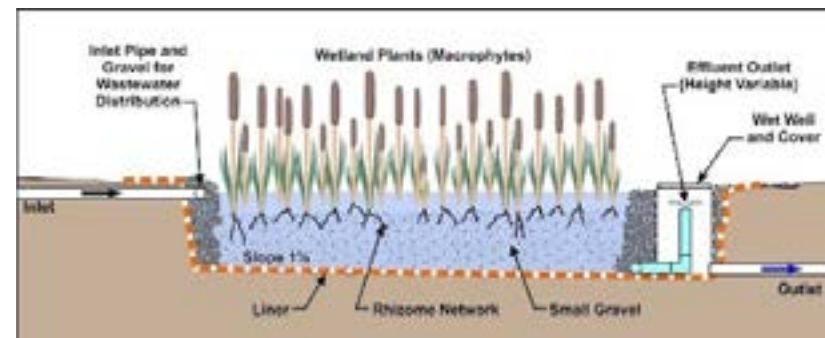

**Subsurface flow** wetlands are generally constructed with a porous material such as soil, sand, or gravel for a substrate. They are designed so that water flows below the ground surface through the substrate. Treatment in the subsurface flow system is more efficient than in the surface flow wetland because the media provides a greater number of small surfaces, pores, and crevices where treatment can occur. Contaminant-degrading bacteria can attach themselves to the various surfaces, and waste materials in the water may become trapped in the pores and crevices on the media and in the spaces between media. Sites with sandy or other highly permeable native soils may require that a liner be installed to retain water in the wetland and prevent the infiltration of the waste stream into groundwater. Some applications of treatment wetlands, such as for treatment of municipal and agricultural wastewater, require pretreatment of the water.

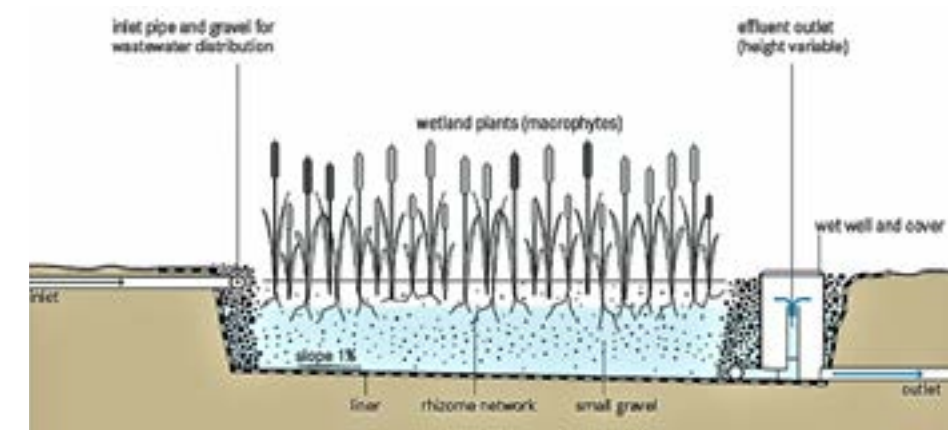

## WASTEWATER GARDENS

These gardens are essentially small, residential scale constructed wetlands. They are shallow, flat bottomed lined trenches or beds, filled with 6 inches of crushed stone and covered with 12 inches of sharp sand. Perforated pipes on the stone and beneath the sand distribute the filtered wastewater along the length of the trenches. The trenches should be no more than 18 to 24 inches deep to maximize the uptake of water and nutrients by plant roots and to allow proper oxygenation. Air is introduced by venting the distribution pipes with riser vents, or breezers. Plants species are selected for their hardiness, rapid growth rates, and high-water requirements. As the plants are either harvested or naturally defoliate, contaminants are removed from the systems. These gardens are more efficient treatment 'facilities' when protected from rain and snow, preferably in a warm greenhouse.

The typical average outdoor rates of processing in the temperate zones of the U.S. and Canada are from .05 to .02 gallons per day. This can be increased to .5 to 3 gallons per day by enclosing the beds in a greenhouse or translucent cover.

Andrew Millisons' video on how biological water treatment works: [www.youtube.com/watch?v=f-sRcVkJZ9yg](https://www.youtube.com/watch?v=f-sRcVkJZ9yg)



# GREYWATER SYSTEMS

## GREYWATER VS BLACKWATER

Greywater is washing water from bathtubs, showers, sinks, washing machines, and dishwashers.

Graywater accounts for 50 – 80% of all combined residential sewage, and could potentially supply most, if not all, of a home's landscape (and orchard) irrigation requirements.

They work on the same principles of constructed wetlands and infiltration basins; they are systems designed and sized to purify wastewater with the help of the plants and soil bacteria. The difference is that the water is applied to the soil directly, with care.

## GREYWATER SYSTEM COMPONENTS

1. Greywater source
2. Collection plumbing
3. Surge tank, filter, and pump, depending on the system you choose
4. Distribution plumbing
5. Receiving landscape
6. People who will use and maintain the system.

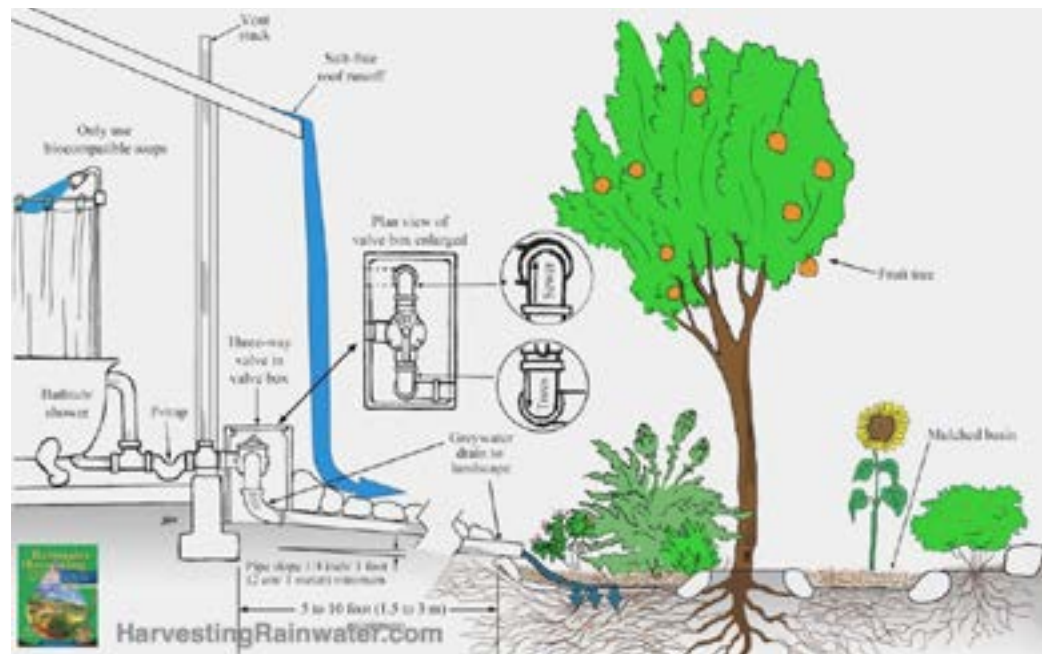

## PERCOLATION RATE

Greywater systems need soil that has a good percolation rate. Percolation is the infiltration of water into the soil, and percolation rate measures the speed at which water infiltrates. If the percolation rate is too slow, the greywater could puddle and become anaerobic unless the system is designed to accommodate this.

In order to test your perc rate for greywater systems, you only need to dig 6-12" down. The majority of biological life in the soil (the beings that will purify your water) live in the first foot of soil.

1. Dig holes to greywater discharge depth, usually 6-12", 15-30 cm., in the locations you wish to discharge greywater. Rough up the sides, just in case you created sealing in the soil pores.
2. Place stakes marked with height levels into the bottom of the hole firmly.
3. Fill the hole with water and let it soak in, possibly several times. You want to saturate the surrounding soil. For most percolation tests, maintain a 12-inch water depth in the hole for at least four hours, and preferably overnight, before measuring the percolation rate. In clay soils, keep the hole filled for at least 12 hours to allow the soil to swell. Soils with moderately slow permeability and/or containing more than 30 percent clay in the testing zone will need several days of saturation when the soil is dry in order to get an accurate reading. In sandy soils, soaking is unnecessary; if, after filling the hole twice with 12 inches of water, the water seeps completely away in less than 10 minutes, proceed with the test immediately.
4. Mark reference elevations on the stakes and fill the holes with water two to four times, measuring each time.

**The percolation rate is the average time in minutes required for water to fall 1 inch, or 2.5 cm.**

Convert the numbers to perc rate in inches or centimeters. If it takes hours for the water to drop or the water vanishes as fast as you fill the hole, or if the hole fills with water by itself you have a less-than-deal soil situation. If the perc is slow, consider a constructed wetland/wastewater garden alternative to water purification. If it is fast, add compost, mulch, and plants that will develop a dense network of roots to help purify greywater on its journey through the soil.



**Area needed to receive greywater based on your perc rate and amount of greywater**

Percolation Rate	Loading Rate Gal/Day/Ft2	Area Needed Ft2/Gal/Day	Soil Infiltration Rat /Min/Cm	Loading Rate M3/Day/M2	Area Needed M2/M3/Day
0-30	2.5	0.4	0-75	.01	10
40-45	1.5	0.7	100-110	.06	20
45-60	1.0	1.0	110-150	.04	25
60-120	0.5	2.0	150-300	.02	50

**NEEDS FOR GOOD GREYWATER PROCESSING:**

1. Good amount of contact time with the plants and soil (reduce flow or increase area).
2. Lots of micro-surface. The more surface area available for contact, the better the treatment quality. This can be facilitated with more plant roots, good loamy soil, and compost.
3. Moisture, oxygen, and nutrient levels that will support growth and survival of roots and bacteria. Design for a good rate of water application. We don't want to create saturation, which will cause anaerobic conditions, or have it become too dry, which will desiccate the bacteria and can kill the plants.
4. Apply wastewater as close to the surface as possible. 90% of the soil life is within a foot of the surface.
5. Use appropriate plants. Evergreens, water loving and salt-tolerant plants, wetland plants.
6. Warmth facilitates the treatment process. Some folks choose to run their greywater systems in greenhouses in frozen climates instead of diverting the water to a septic or sewer when the ground is frozen.



**GREYWATER SYSTEM DESIGN DECISIONS**

There are a few baseline things that need to be considered when deciding the best design approach for your greywater system.

**1. Separate flows or Combined Flow?**

Do you want to separate the different greywater flows from the different sources (washing machine, shower, kitchen sink, etc..) or combine the flows before piping out to your irrigation zones?

Separate flows are appropriate if you have a large house, when rerouting plumbing from one side to another is difficult or impossible (such as in the case of slab on grade construction), the land around the house is very flat, or the house is more than one story and part of the yard is above the ground floor.

Combined flows are appropriate if your home is designed to facilitate combined plumbing, you want the highest reuse efficiency for your irrigation, or you want to be able to switch between multiple irrigation zones with the same water source.

**2. Simplicity**

Make every part of the system find-able, accessible, maintainable, replaceable, and flexible. Simple and accessible designs will be the ones that last.

**3. Design with Fall/Slope as the Central Consideration**

Fall is the vertical distance between the greywater source and its destination. Proper slope is critical. The best slope is a ¼" fall per foot, or a 2% slope. At steeper slope, water tends to leave the solids behind, and at a smaller slope, the velocity won't be enough to move the greywater through well.

Realize that this is very different than conventional plumbing, so if you are working with a plumber for help, this point will need to be emphatically addressed.

**All plumbing should be set as high as possible.**



#### 4. Build for future flexibility

Try to leave enough pipe between fitting so they can be sawn apart and reconfigured.

Valves and dipper boxes should be installed with no hub connectors or silicone sealer instead of ABS glue on fittings

Having multiple zones and maintain aerobic conditions, divert greywater to disposal when irrigation is not needed, divert greywater to disposal or spread it more widely

Make sure to divert greywater from traps and vents

#### 5. Use size appropriate fittings and pipes

If your pipes are too big, solids can rest on the bottom of the pipe and not move through. If your pipes are too small, your pipe may overload or clog.

- A 2" pipe is a good main pipe size, and 1 1/2" is good for branched distribution lines
- Make sure you use 'sanitary' pipe fittings rather than 'supply' fittings. Sanitary fittings have a gentle curve as opposed to a right angle.
- Design your system with shutoff valves that can re-direct your wastewater to a sewer, septic, or alternative receiving location in case of toxics in your waste stream, freezing-climate months, or other needs. You can also plumb with valves to be able to direct the flow to your different irrigation needs.

Because greywater has salts, along with the nutrients, the system should be flushed out with rainwater from time to time. In areas that receive abundant rain, the natural rain cycles will be enough to flush your system. In dryland areas, greywater systems can be matched with rainwater collection cisterns to provide a good soil flush a couple times a year.

## GREYwater SYSTEM DESIGN DECISIONS

Greywater systems can be designed to be very involved, with underground piping and pumps, filters, and surge tanks, or can be simple, gravity fed systems that are designed for easy access.

Depending upon your plumbing skill and technical capacity, if you are designing a home system yourself, you may want to aim initially for the two simplest designs: Branched Drain, and Laundry to Landscape.

### BRANCHED DRAIN TO MULCH BASINS OR MINI-LEACHFIELDS

For situations with continuous downhill slope from the points of greywater generation to the points of irrigation need, this design is inexpensive and efficient without the need for filters or pumps. Again, it is critical that hard-plumbed lines have proper slope (at least 1/4" per foot).

One way to split the greywater flow to accomplish wider distribution is to not combine the flows in the first place; each fixture waters its own area. This approach works best as primary irrigation, with each flow matched to an appropriately sized, established tree.

Another way to split the flow is by using "double ells," pictured here. These are difficult to find, and we recommend purchasing them directly from Oasis Design, who manufactures them with the inspection opening displayed in the image. The maximum number of splits is four, to maintain good flow distribution.

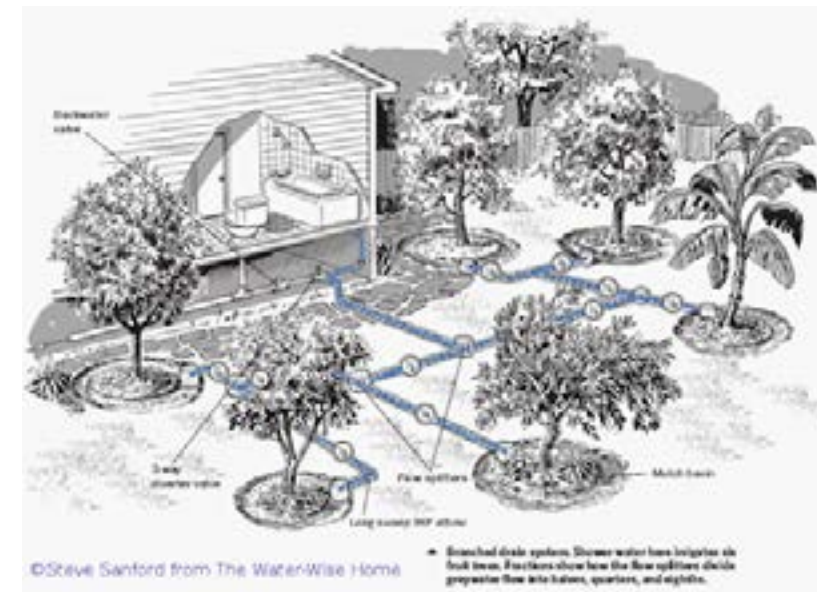



## GREYWATER SYSTEM DESIGN DECISIONS

One of the simplest designs involves only the greywater from your washing machine, called “Laundry-to-Landscape.” If your washing machine is located near an exterior wall, this plumbing task and the slope needed to achieve good flow is relatively easy.

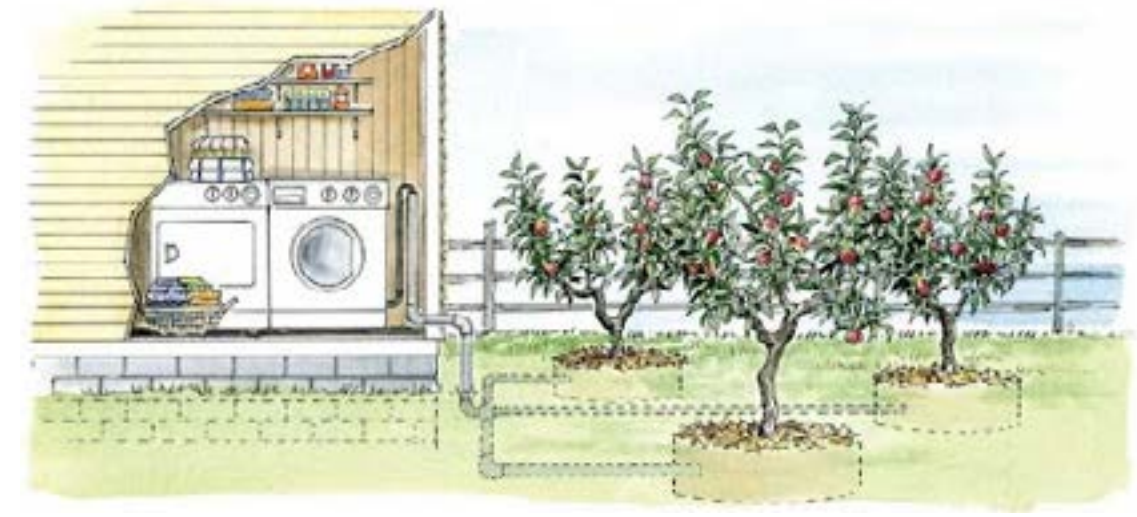

Here is a video on how to DIY a Laundry to Landscape system!  
[www.youtube.com/watch?v=G1VW44wHXGc](http://www.youtube.com/watch?v=G1VW44wHXGc)

### INTERIOR PLUMBING FOR GREYWATER

Greywater systems should be plumbed with diverter valves that allow the water to flow to the system, and then back to conventional septic/sewer if the connection is retained. Alternatively, if there is no septic or sewer, the diverter can be to different receiving areas. We recommend a receiving area be planned as the diversion area for accidental toxics in your water flow.

**The greywater plumbing needs to be done farther down the line from the P-trap and vents.**

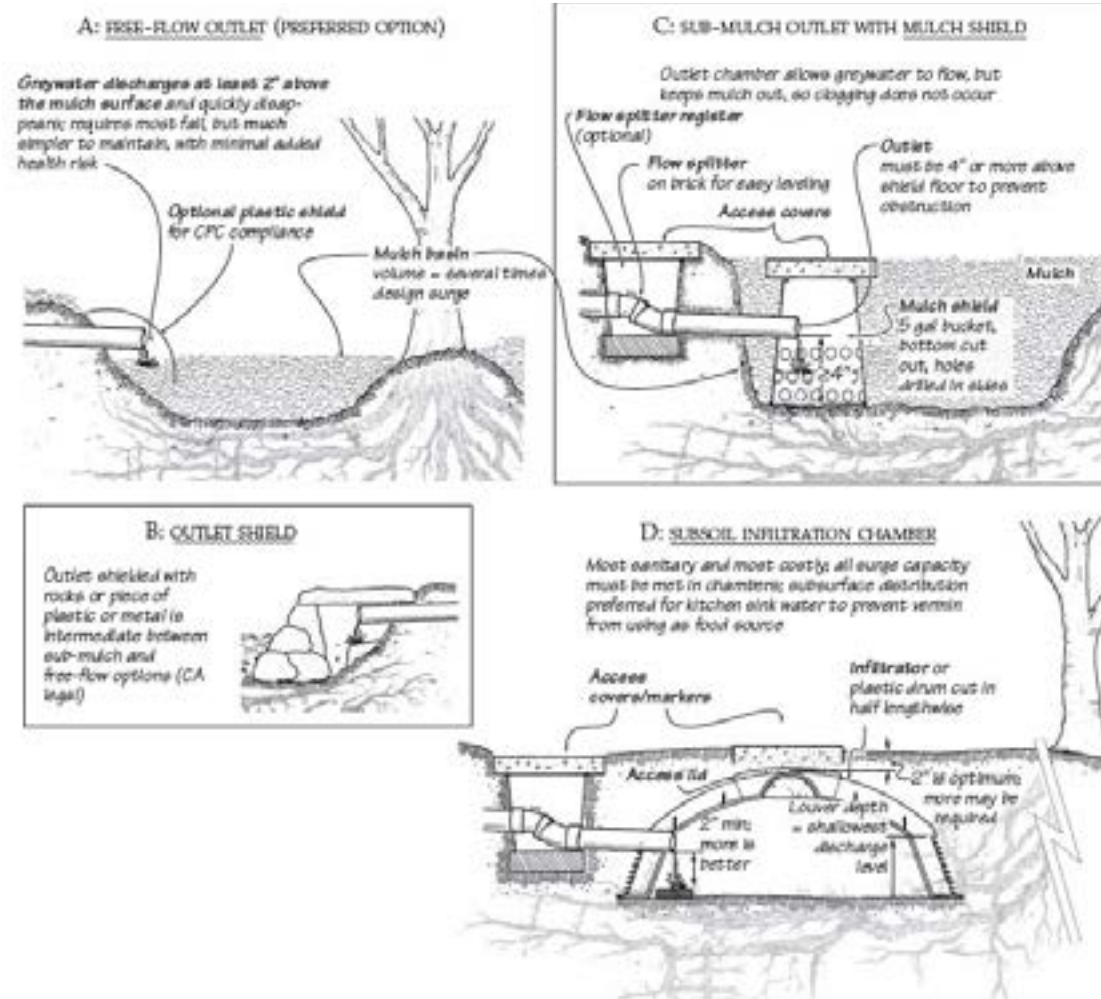
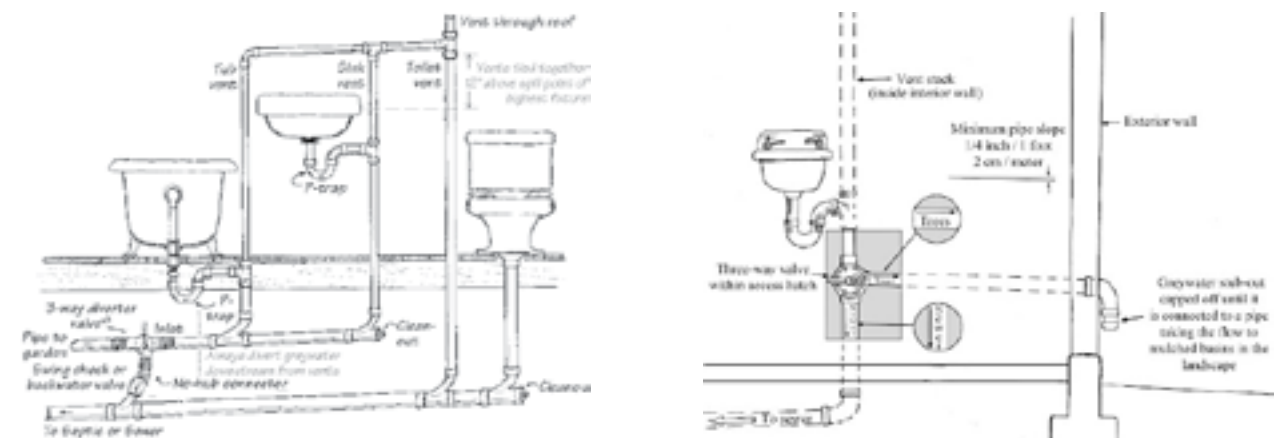

### Different mulch basin outlet options, from Builders' Greywater Guide, Oasis Design

A detailed description of the branched drain system and connections can be found on the Rainwater Harvesting for Drylands website at:

[www.harvestingrainwater.com/resource/branched-drain-greywater-distribution-plumbing/](http://www.harvestingrainwater.com/resource/branched-drain-greywater-distribution-plumbing/)

## CARING FOR YOUR GREYWATER SYSTEM

### SOAPS

Soaps are alkali salts of long chain fatty acids, which emulsify soils, microbes, and liquids and detach them from surfaces, breaking the bonds that hold them to surfaces, allowing them to be rinsed away.

Most soaps are made with sodium hydroxide. The use of sodium-based soaps increases the amount of sodium in greywater, while hydroxide raises the pH, or alkalinity. In some plants, sodium inhibits water and nutrient transport. Potassium based soaps are better to use, because potassium is a fertilizer and a beneficial nutrient. Most liquid soaps are made with potassium hydroxide. Potassium hydroxide is an excellent grease remover, turning the grease itself into soap.

There are highly effective soaps that are made specifically to biodegrade into quality plant nutrients; Biopac, and Oasis soaps. These can be found in natural food stores or ordered, and the brands have a wide variety of products. Dr. Bronners or other pure castile or liquid soaps that use potassium instead of sodium are also good.

### DEGREASING CLEANERS

D-Limonene is the active ingredient in recently available cleaners such as CitraSolv. It is an organic extract derived from citrus oils, is 100% biodegradable, noncorrosive, and contains no petroleum solvents.



### INGREDIENTS TO AVOID

Ingredient formulas in consumer products may change, so read product labels every time you buy soaps or detergents.

- sodium and ingredients with the word “sodium” or “salt” in them
- boron/borax (toxic to plants)
- sodium perborate
- petroleum distillate
- anti-bacterial soaps and cleaners
- “whiteners” and “softeners”
- chromium oxide
- artificial colors, FD&C colors
- synthetic fragrance
- artificial preservatives
- parabens (methyl, propyl, butyl, and ethyl)
- chlorine bleach / sodium hypochlorite (household bleach)\*

*\*Hydrogen peroxide is an acceptable alternative.*

## GRAYWATER AND THE MAGIC C:N RATIO

The carbon to nitrogen ratio of greywater is not ideal for efficient microbial breakdown in planted irrigation systems. The detergents, soaps, soils, fats, and grease in greywater add a lot of carbon to it, but it has relatively little nitrogen. Too little nitrogen will result in a buildup of undigested material, which may clog pipes and drains, and smell bad.

Extra nitrogen can be provided by protein containing shampoos (Neutrogena, Pantene), ammonium laureth or lauryl sulfate containing cleaners, or urine.

Before installing ecological water treatment infrastructure, we recommend that experienced plumbers consult the Builders’ Guide to Greywater, or Create an Oasis with Greywater from Oasis Design.



# COMPOSTING TOILETS

To design our communities and Nations to truly honor water in practice, we recommend standardly utilizing composting toilets, which use no water and produce fertilizer. Use of water toilets actively contaminates clean water, and is wasteful, using just under two gallons of clean water per flush.

Composting toilets are just as sanitary as flush toilets, more so in consideration of the fact that contaminated water is difficult to manage. The simplest and cleanest composting toilet, the 'sawdust toilet,' is appropriate for homes that have the ability to maintain a basic backyard composting system, but there are also systems that can work in apartment buildings, office buildings, and other multistory, more urban locations. The Wampanoag Tribe has demonstrated their commitment to honoring water by designing their new Tribal Headquarters to be a model of ecological design features, including greywater systems and composting toilets. We encourage our Nations to develop demonstration sites for this technique to allow our peoples to experience how clean and simple it is.



## WHAT IS A COMPOSTING TOILET?

A composting toilet system is designed to support the effective composting of human manure, producing an enriching soil additive.

There are commercially produced composting toilets that include;

- A composting reactor connected to one or more dry or micro-flush toilets
- A screened exhaust system (often fan-forced) to remove odors, carbon dioxide, and water vapor
- A means of ventilation
- A means of draining and managing excess liquid (leachate)
- Process controls, i.e. mixers
- An access door for removal of the end product

*\*All this is not necessary*

## THE SAWDUST TOILET

Mechanical composters can fail with improper maintenance, and require electricity. Often, the simpler solution is the best. Sawdust toilets are simple, easy to maintain and require no electricity or other inputs. You can add one to your bathroom in a home, or rental home and it costs almost nothing to build.

## HOW TO USE A SAWDUST TOILET

1. After you use the toilet, even simply to urinate, add a layer of cover material. The contents of the toilet are kept covered at all times with a clean, organic cover material such as sawdust, peat moss, forest leaves, rotted wood, rice hulls, shredded newspaper, straw, or grass clippings, in order to prevent odors, absorb urine, and eliminate any fly nuisance. This is the 'biofilter' that will prevent odor. Sawdust from a sawmill where trees are cut into boards is both moist and biologically active and makes a very effective biofilter. Kiln-dried sawdust is too light and airy to be a 100% effective biofilter. Sawdust from wood-working shops may contain hazardous chemical poisons if "pressure-treated" lumber is being used there.
2. When the bucket is full, it is carried to the composting area and deposited in the pile. It is best to dig a slight depression in the top center of the compost pile and put the fresh material there, in order to keep the incoming humanure in the hotter center of the compost pile. Then cover it again with additional clean, bulky, organic material such as straw, leaves, or weeds, in order to eliminate odors and to entrap air as the pile is built.
3. Then wash the bucket with a small quantity of water, which can be rainwater or greywater, and biodegradable soap. A long-handled toilet brush works well for this purpose. Often, a simple but thorough rinsing will be adequate. This wash water is then poured onto the compost pile. It is surprising how clean this process is – often less off-putting than cleaning a regular bathroom, because the sawdust, straw, or leaves typically prevents poop from touching the sides of the bucket.

The rinse water cannot be allowed to pollute the environment. The best way to avoid this is to put the rinse water on the compost pile, as stated. It can also be poured at the base of a tree or shrub that is designated for this purpose. Such a tree or shrub should have a thick layer of organic material (biological sponge) at its base. Finally, never use chlorine to rinse a compost bucket. Chlorine is a chemical poison that is detrimental to the environment and is unnecessary. Simple soap and water is adequate.

After rinsing or washing, the bucket is then replaced in the toilet area with a fresh layer of sawdust or material of choice.



## The Compost Bins

Excerpt From *The Humanure Handbook*, Joseph Jenkins

Use at least a double-chambered, above-ground compost bin, with a lid if you live in a damp climate to prevent rain from washing through your pile. A three-chambered bin is recommended, with one active bin, one seasoning/aging bin, and one bin to contain the organic matter/straw used to cover the compost after you add fresh material to the pile. Deposit in one chamber for a period of time, about a year, then switch to another for an equal period of time.

Two factors are involved in destroying potential pathogens in compost. Along with heat, the time factor is important. Once the organic material in a compost pile has been heated by thermophilic microorganisms, it should be left to age or “season.” This part of the process allows for the final decomposition to take place, decomposition that may be dominated by fungi and macroorganisms such as earthworms.

Put all of your compost, including kitchen scraps, into the same bin. You do not need to separate these materials.

Keep good access to the pile in order to rake the top flat, to apply bulky cover material when needed, to allow air to access the pile, and to monitor the temperature of the pile. The advantage of aerobic composting, as is typical of an above-ground pile, over relatively anaerobic composting typical of enclosed composting toilets, is that the aerobic compost will generate higher temperatures, thereby ensuring a more rapid destruction of potential human pathogens.

Compost bins can easily be made from free shipping pallets, wired or screwed together.

A compost pile can accept a huge amount of refuse, and even though the pile may seem to be full, as soon as you turn your back it will shrink down and leave room for more material. A year is a good period of time for doing so in any area where there is an annual growing season. In the cold winters of the north, it is quite likely that the compost will freeze solid. You can, however, keep adding to the pile all winter. In the spring when it thaws out, the compost should work up a head of steam as if nothing happened.



## SAWDUST TOILET CONSTRUCTION

The compost bucket sits directly on the floor. A standard toilet seat is attached to an 18” square piece of plywood, which lifts up on hinges to allow easy access when removing the compost material. A complete description of the sawdust toilet method, including materials and construction diagrams, is available at this website.

[library.uniteddiversity.coop/Composting\\_and\\_Recycling/Compost\\_Toilets/Humanure\\_Instruction\\_Manual.pdf](http://library.uniteddiversity.coop/Composting_and_Recycling/Compost_Toilets/Humanure_Instruction_Manual.pdf)

We give thanks to Joseph Jenkins, author of ‘The Humanure Handbook’ for his decades of research and advocacy.

## FINAL WORDS

From home-scale to nation-scale, the practice of working with the natural processes of our Mother Earth to purify Water inherently brings people into a good reconnected relationship with life's forces. Water, as the source of life, requires continuous care, protection, and infrastructure changes that reflect a good way of living. Former Governor Frank Tenorio of San Felipe Pueblo expressed this responsibility, saying,

*“There has been a lot said about the sacredness of our land which is our body; and the values of our culture which is our soul; but water is the blood of our tribes, and if its life-giving flow is stopped, or it is polluted, all else will die and the many thousands of years of our communal existence will come to an end.”*

We understand this urgency, and are carrying out our responsibilities on many fronts across our Nations. From front lines to courtrooms, from prayer offered and community networks built, to Indigenous decision-makers, designers, planners, architects, and engineers are implementing the water infrastructure changes we need to come back into balance. Each one of us holds the power to rebalance the world in large and small ways. The Water is calling us to step into this power, to work towards the return of healthy and clean ecologies and communities for our descendents.



## RESOURCES

### WATER RIGHTS

'Treatment as a State' Application and Tribal Water Standards

<https://www.epa.gov/wqs-tech/epa-actions-tribal-water-quality-standards-and-contact>

Keepers of the Water

First Nations, Métis, Inuit, environmental groups, concerned citizens, and communities working together for the protection of water, air, land, and all living things within the Arctic Ocean Drainage Basin

<https://www.keepersofthewater.ca>

Article on River Personhood in Aotearoa

<https://apnews.com/article/religion-sacred-rivers-new-zealand-86d34a78f5fc662ccd554dd7f578d217>

Global Alliance for the Rights of Nature

<https://www.garn.org/rights-of-nature/>

### RAINWATER HARVESTING

Rainwater Harvesting Resource

<http://www.harvestingrainwater.com>

Green Infrastructure Guide

<https://www.tucsonaz.gov/files/transportation/2006WaterHarvesting.pdf>

Rainwater System sizing assistance:

<https://www.rainbrothers.com/how-to-size-your-rain-harvesting-system>

DIY Culvert Cistern Installation

[https://www.youtube.com/watch?v=6\\_budXC3oYU](https://www.youtube.com/watch?v=6_budXC3oYU)

### CONSTRUCTED WETLANDS/GREYWATER SYSTEMS

Arcata Marsh

City-scale constructed wetland for sewage treatment and ecological restoration

<https://www.arcatamarshfriends.org/the-marsh/about-the-arcata-marsh-wildlife-sanctuary/>

Tulalip Tribe Stormwater Wetland

<https://nwtreatytribes.org/tulalip-tribes-engineer-wetlands-to-treat-stormwater/>

Biohabitats

Constructed Wetland system consultants and installers

[www.biohabitats.com](http://www.biohabitats.com)

Oasis Design

Greywater, ecological design resource

[www.oasisdesign.net](http://www.oasisdesign.net)

Informational Resource for Greywater Systems

<http://oasisdesign.net/catalog/>

Earth Repair

Grassroots Bioremediation, purifying water and soils

[www.earthrepair.ca](http://www.earthrepair.ca)

Cleaning Product Sources for Graywater Systems

These can be found in local natural food stores, but can also be ordered online.

Oasis Soap

<https://www.bio-pac.com/oasis-biocompatible-cleaners/>

Citra-Solv Cleaner

<https://www.citrasolv.com/concentrate>

## COMPOSTING TOILET SYSTEMS

Composting Toilet Condensed Information

[http://humanurehandbook.com/downloads/Humanure\\_Manual\\_2019.pdf](http://humanurehandbook.com/downloads/Humanure_Manual_2019.pdf)

Build your own sawdust toilet

[https://humanurehandbook.com/downloads/Loo\\_Construction.pdf](https://humanurehandbook.com/downloads/Loo_Construction.pdf)

## US FEDERAL FUNDING

Federal Funding for Tribal Drinking Water

<https://www.epa.gov/tribalwater/funding-opportunities-tribal-drinking-water-programs>

Grants for Rural and Native Alaskan Villages

Drinking water/waste disposal

<https://www.rd.usda.gov/programs-services/grants-rural-and-native-alaskan-villages>

Water & Waste Disposal Loan & Grant Program

<https://www.rd.usda.gov/programs-services/water-waste-disposal-loan-grant-program>

Water & Waste Disposal Loan Guarantees

<https://www.rd.usda.gov/programs-services/water-waste-disposal-loan-guarantees>

Water & Waste Disposal Predevelopment Planning Grants

<https://www.rd.usda.gov/programs-services/water-waste-disposal-predevelopment-planning-grants>

Water & Waste Disposal Revolving Loan Funds

<https://www.rd.usda.gov/programs-services/water-waste-disposal-revolving-loan-funds>

Water & Waste Disposal Technical Assistance & Training Grants

<https://www.rd.usda.gov/programs-services/water-waste-disposal-technical-assistance-training-grants>

SEARCH - Special Evaluation Assistance for Rural Communities and Households

<https://www.rd.usda.gov/programs-services/search-special-evaluation-assistance-rural-communities-and-households>

## CANADA-BASED FUNDING AND ASSISTANCE

First Nations Infrastructure Institute

Development partner for water and other infrastructure

<https://fnii.ca/fnii-projects/>

List of Province by Province funding opportunities

<https://fcm.ca/en/resources/cedi/first-nation-municipal-funding-resources>

Indigenous Community Infrastructure Fund

<https://cib-bic.ca/en/sectors/indigenous-infra/>

## MEXICO-BASED RESOURCES

Programa de Agua Potable, Drenaje y Tratamiento

[https://www.dof.gob.mx/nota\\_detalle.php?codigo=5639902&fecha=31/12/2021](https://www.dof.gob.mx/nota_detalle.php?codigo=5639902&fecha=31/12/2021)

Programa de Apoyo a la Infraestructura Hidroagrícola

[http://www.dof.gob.mx/nota\\_detalle.php?codigo=5639621&fecha=29/12/2021](http://www.dof.gob.mx/nota_detalle.php?codigo=5639621&fecha=29/12/2021)

Manual de cosecha de agua de lluvia en áreas urbanas

<https://www.sedema.cdmx.gob.mx/storage/app/media/DGCPCA/ManualCosecharLaLluvia.pdf>

Guía en Defensa del Agua, los Bosques y las Selvas, CEMDA

<https://www.cemda.org.mx/wp-content/uploads/2021/06/CEMDA-Gui%C3%A1-2-Agua-17may.pdf>

Información sobre la contaminación del acuífero maya

[https://www.dplf.org/sites/default/files/informe\\_contaminacion\\_acuifero\\_maya.pdf](https://www.dplf.org/sites/default/files/informe_contaminacion_acuifero_maya.pdf)

Información general, integral y amplia sobre el agua en México.

<https://agua.org.mx/que-es/>

Manual de construcción de cisternas de ferrocemento.

<http://indesol.gob.mx/cedoc/pdf/III.%20Desarrollo%20Social/Ecotecnias/Manual%20de%20Construcci%C3%B3n%20de%20Cisternas%20de%20Ferrocemento.pdf>

Sistema doméstico de cosecha de agua.

[https://sswm.info/sites/default/files/reference\\_attachments/GUTI%C3%89RREZ%20y%20BULNES%202016.%20Sistema%20dom%C3%A9stico%20de%20cosecha%20de%20agua%20lluvia.pdf](https://sswm.info/sites/default/files/reference_attachments/GUTI%C3%89RREZ%20y%20BULNES%202016.%20Sistema%20dom%C3%A9stico%20de%20cosecha%20de%20agua%20lluvia.pdf)

Base de datos sobre el uso del agua en México, concesiones, permisos, cuencas.

<https://www.gob.mx/conagua/acciones-y-programas/registro-publico-de-derechos-de-agua-repda-55190#:~:text=El%20Registro%20P%C3%ABlico%20de%20Derechos,y%20sus%20bienes%20p%C3%ABlicos%20inherentes.&text=Salvaguardando%20los%20derechos%20inscritos%20y,obtener%20constancia%20de%20los%20mismos>

IRRI México, programa de seguridad hídrica.

<https://irrimexico.org/programas/programa-seguridad-hidrica/>